

High Bay LED Sports Series - 60W

Lamp Comparison



Conventional Halide	
Bulb	200 Watt Metal Halide
Rated Lifespan	20,000 hours
Ballast Rated Lifespan	20,000 hours
Ballast Consumption	10 - 20% More Energy
CRI	65
Lumen Depreciation	20% at 8,000 hrs
Mercury Concentration	High

LED Sport Series - 60W	
Bulb	60 Watt LED
Rated Lifespan	50,000 hours
Ballast Rated Lifespan	None
Driver Consumption	5 Watts
CRI	75 - 87
Lumen Depreciation	2% at 8,000 hrs
Mercury Concentration	None

Summary of Data			
Model:	Sport Series 60w – Premium Plus		
Certifications:	DLC, UL, FCC, PSE, ROHS, CE, IP63		
Consumption:	65W		
Input Voltage:	100-277V AC		
Frequency:	50-60Hz		
Color:	Warm white	Neutral white	Daylight
Color Temp:	3000K	4500K	6000K
Rated Lumens:	5,100 lm	5,700 lm	6,000 lm
Efficacy:	85 lm/w	95 lm/w	100 lm/w
CRI:	87	>83	>75
Power Factor:	>0.95		
Life Time:	>50,000hrs		
Housing Material:	Aluminum Alloy, High Grade Plastic		
Beam Angle:	45° / 90° / 120°		
Operating Temp:	-30°C to 65°C		
Warranty:	5 Years		
Dimmable:	Yes		
Integral High Efficiency Driver and Power Supply			
Product Features	Lower Energy Cost & Quick Payback Longer Lamp Life & Lower Fixture Cost Instant On Easy to Install Better Lighting. Better Games.		

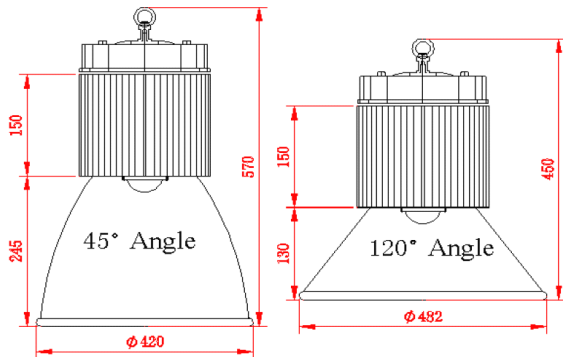

Illumination Cone Curve

